

4800

HAND DRAWN
WIDE TRACK

4800

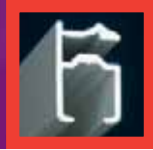

G-RAIL[®]
ALUMINIUM RAIL

> *by Goelst*



Profile 4800 is suitable for light to medium-heavy curtains and features the optional use of gliders or rollers.

The strength of this profile allows a greater distance between fixing bracket centres.

This is beneficial when using special clips to fix to a suspended ceiling grid where standard width ceiling tiles have to be bridged.

Standard colours: White RAL 9010, natural. Special colours on request.

**HAND DRAWN
WIDE TRACK**

4800



4800 > The sturdy for the

Installation

Face fixing with wall bracket 5351

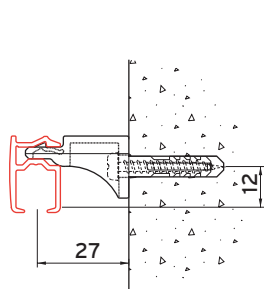

Top fixing with ceiling bracket 5350

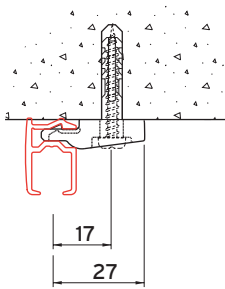

Top fixing with double bracket 2216-53 and ceiling bracket 5350

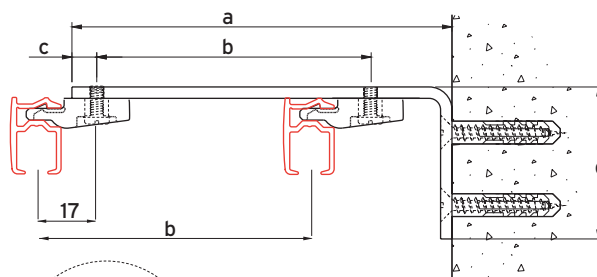
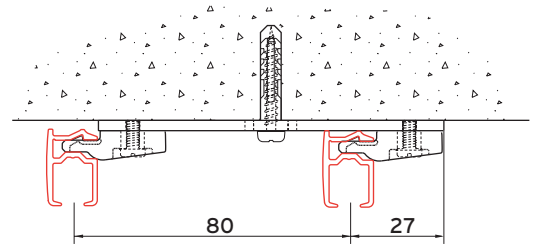

[mm]	a	b	c	d	e	f
2015-05	50	-	6.5	40	16	3
2015-07.5	75	47	6.5	40	16	3
2015-10	100	72	6.5	40	16	3
2015-15	150	72	6.5	40	16	3
2018-15	150	57 / 57	6	80	20	4
2019-20	200	80	6.5	60	20	4
2019-25	250	80	6.5	60	20	4
2019-30	300	80	6.5	60	20	4

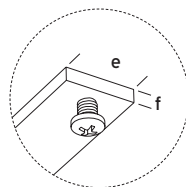

end view detail of extension bracket

fixing with extension bracket 2015, 2018 or 2019 in combination with ceiling bracket 5350

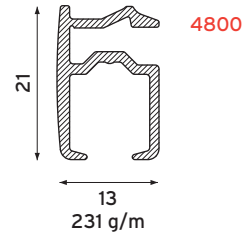
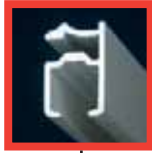

Specification Guide

G-Standard (bracket fixing guide)

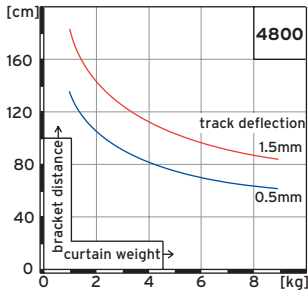

Extension bracket	Load (kg)		
	1	2	4
2015-15	2	5	10
2018-15	1	2	4

Deflection (in mm) of the bracket 2015-15 and the stronger bracket 2018-15

Material:

Aluminium 606035-T6-F22. (Higher specification than DIN 1725). Shape and size tolerances are in accordance with DIN 17615. White RAL 9010 powder coated in accordance with the Qualicoat standard. Special colours on request. Profile weight: 231 g/m.

Accessories:

Gliders 4010 at 10 - 16 per metre with 2 end stops 4001 per length.

Installation:

Ceiling fixing with synthetic bracket 5350 or with double bracket 2216-53 in combination with ceiling bracket 5350.

Face fixing with synthetic wall bracket 5351. Extension brackets 2015, 2018 and 2019 can be used in combination with ceiling bracket 5350

Bracket fixing centres (cm) in accordance with the G-Standard or the following table.

	light	medium	heavy (curtain)
	110	80	60

Bending:

Minimum radius 10 cm. Bending machine 1015.

profile heavier curtain.

Product example

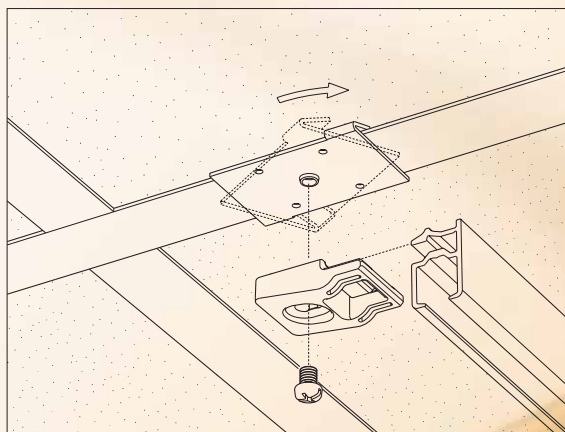



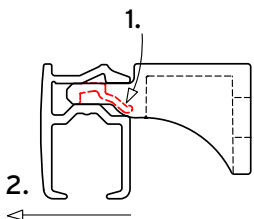









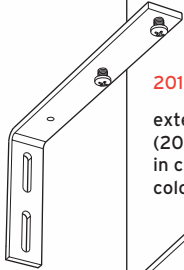



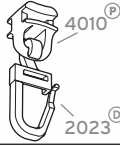
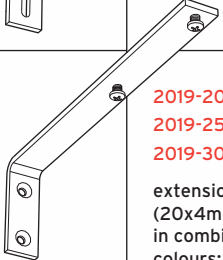



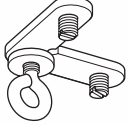



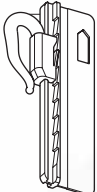

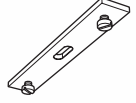

Application of the special clip 2050-SYST-53, for fixing to ceiling grid.

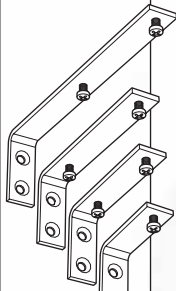

Method for removing profile 4800 from wall bracket 5351.

Components

Product design and specification changes reserved.

CURTAIN TRANSPORT					
	4001 endstop colours: B - G - W		2022 curtain hook		2018-15 extension bracket (20x4mm) heavy duty in combination with 5350 colours: N - W
	4001-A endstop with eye (metal)		2023[ⓓ] curtain hook for 4025		
	4002 endstop		4025 glider 4010 with curtain hook 2023		2019-20 2019-25 2019-30 extension bracket (20x4mm) heavy duty in combination with 5350 colours: N - W
	4003 spring stop		4030 roller colours: B - G - W - ZW		
	4007 rotating glider		4048-10 corner connection with eye	ACCESSORIES	
	4010[Ⓟ] glider (on strip) colours: B - G - W - ZW	CEILING FIXING			4853 endcap colours: GR - W
			5350 ceiling bracket colours: B - G - W		2024-55 adjustable sew-in hook
	4012-10 click glider		2050-SYST-53 T-bar clip for ceiling grid in combination with 5350		4852 connecting bridge
	4012-40 click glider transversed		2216-53 double fixing bracket in combination with 5350		
	4012-50 click glider transversed with hook	WALL FIXING			5080 overlap carrier - to be used in combination with a drawrod:
			5351 wall bracket colours: B - G - W		7399-K plexi drawrod with metal core
	2020 double hook		2015-15 2015-10 2015-07,5 2015-05 extension bracket (16x3mm) in combination with 5350 colours: N - W		7399 plexi drawrod
	2021 G-hook curtain hook			7399-WK steel drawrod white synthetic cover	

**HAND DRAWN
WIDE TRACK**

4800

B = Brown
G = Gold
W = White
ZW = Black

 = Standard item

 = Registered design

 = Patented design

G-RAIL®

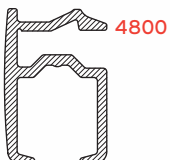

Space for dealer address

03/2004